

1

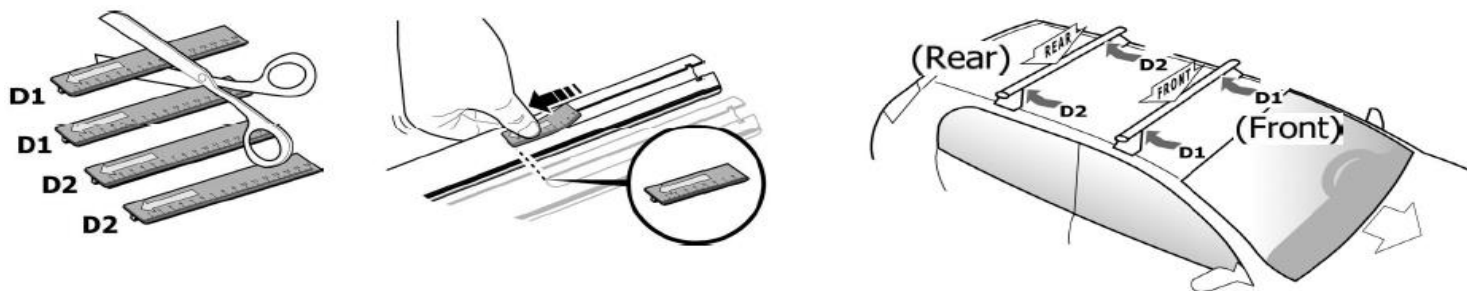

MANUFACTURER	MODEL CAR	DOORS	MODEL YEAR	D1	D2
BMW	Serie 2 (F46) Gran Tourer	5	15>	7,8	7,5
HYUNDAI	Genesis	4	15>	7,9	6,9
HYUNDAI	Tucson (TL)	5	15>	10,4	9,2
MAZDA	3 / Axela (BM)	5	14>	11,5	10,1
MAZDA	6 / Atenza (GJ)	4	16>	11,0	9,5
TOYOTA	C-HR	5	16>	6,2	7,7

2

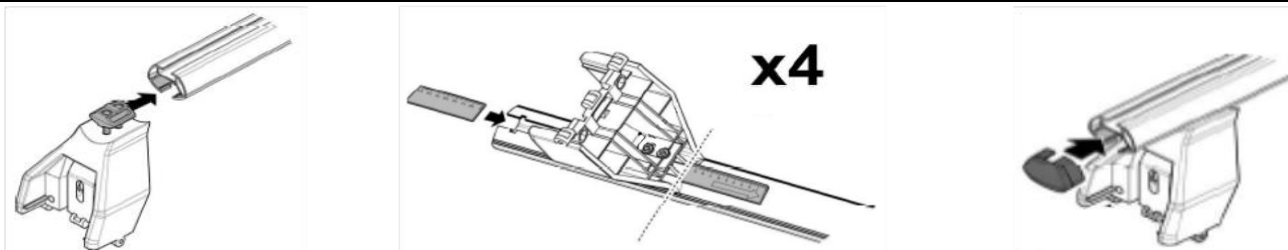

3

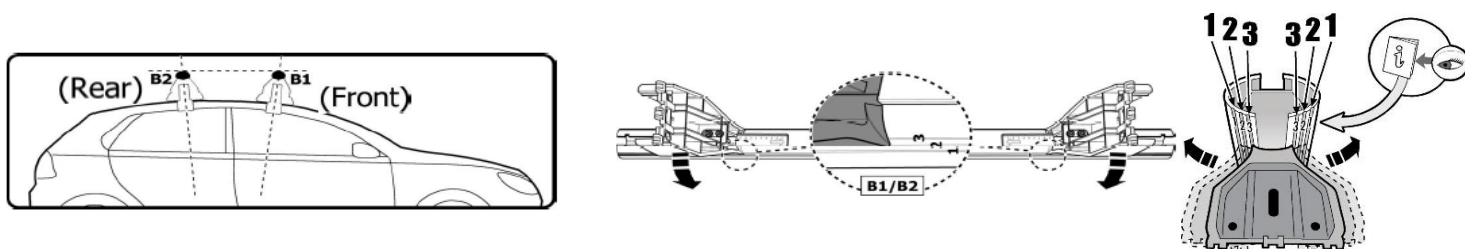

MANUFACTURER	MODEL CAR	DOORS	MODEL YEAR	B1	B2
BMW	Serie 2 (F46) Gran Tourer	5	15>	2	2
HYUNDAI	Genesis	4	15>	2	1
HYUNDAI	Tucson (TL)	5	15>	1	2
MAZDA	3 / Axela (BM)	5	14>	1	2
MAZDA	6 / Atenza (GJ)	4	16>	1	1
TOYOTA	C-HR	5	16>	2	2

4

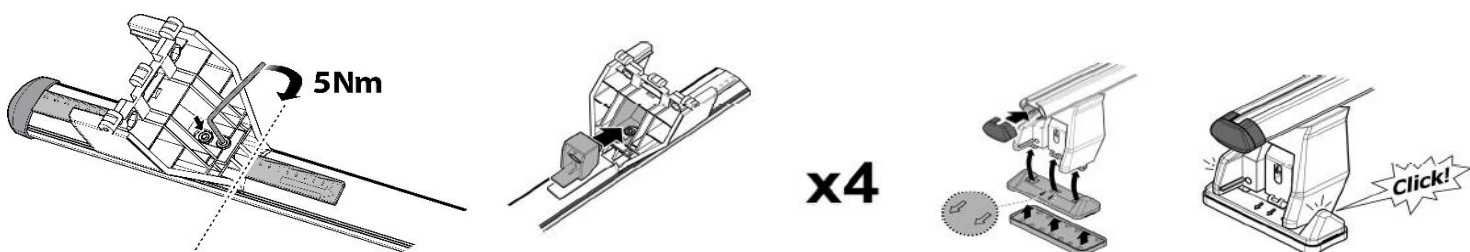

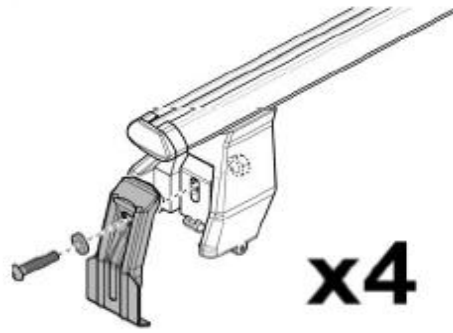

Front X	Rear Y
------------	-----------

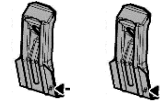

14 2X	50R 2X
----------	-----------

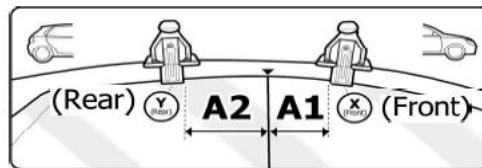
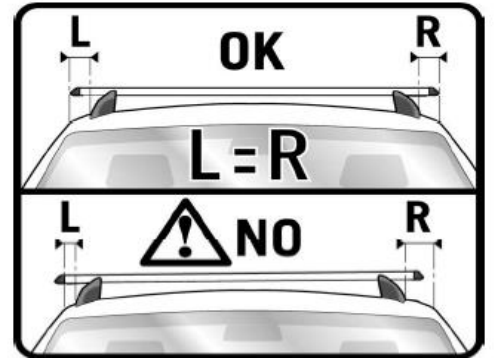
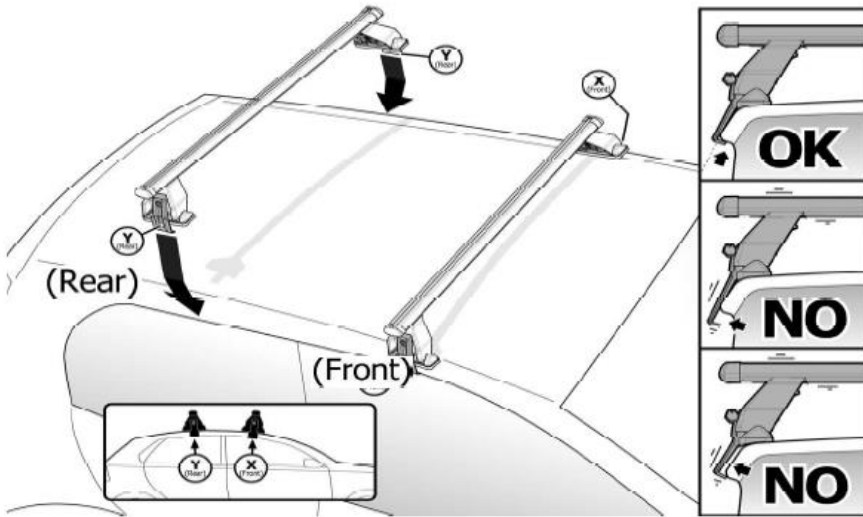

OR

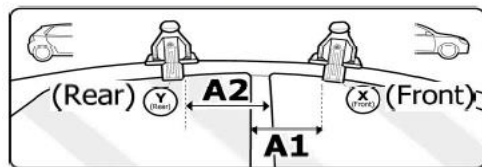

MANUFACTURER	MODEL CAR	DOORS	MODEL YEAR	A1	A2	A1	A2
				cm	cm	in	in
BMW	Serie 2 (F46) Gran Tourer	5	15>	17	51	6,7	20,1
HYUNDAI	Genesis	4	15>	20	40	7,9	15,7
HYUNDAI	Tucson (TL)	5	15>	24	40	9,4	15,7
MAZDA	3 / Axela (BM)	5	14>	25	35	9,8	13,8
MAZDA	6 / Atenza (GJ)	4	16>	25	45	9,8	17,7
TOYOTA	C-HR	5	16>	33	36	13,0	14,2

X = predisposizione originale /original arrangement