

Yangzhou Lettas Baby Product Co., Ltd.	E8*129R03/08*14148*01	Type: T005F
		ID No.: 129-T005F-01
		Date: 2023-11-14
		Page 1 of 29

INFORMATION DOCUMENT

for
EXTENSION No. 1
of the approval No. E8*129R03/08*14148*00
pursuant to

UN REGULATION NO. 129.03
UNIFORM PROVISIONS CONCERNING THE APPROVAL OF:
ENHANCED CHILD RESTRAINT SYSTEMS USED ON BOARD OF
MOTOR VEHICLES
(ECRS)

FOR PRODUCT TYPE:
T005F

Reasons for extension No. 1:

- 1. Alternative trade names;
- 2. Alternative commercial names;
- 3. Add variants

Responsible person: YUTING WANG
Yangzhou Lettas Baby Product Co., Ltd.



Yangzhou Lettas Baby Product Co., Ltd.	Type: T005F
	ID No.: 129-T005F-01
	Date: 2023-11-14
	Page 2 of 29

List of documentation

0. General.....	3
1. Technical description.....	4
Appendix 1: BOM LIST and Drawings.....	6
Appendix 2: Label	25
Appendix 3: Declaration on the toxicity and flammability of used materials.....	26
Appendix 4: Manufacturer’s instruction manual for use.....	27
Appendix 5: Packing info.....	29



0. GENERAL

0.1 Make (trade name of manufacturer):

REEBABY, angelcare, HAPPY YOOTU, YOOREE, REE, BEBESIT, YOUNG, COZY n Safe, SHOM, Babysafe, Kiddo, BABY CODE, ctrl, Koopers, Halford, Felibim, Icon, Evenflo, Happy baby, Safeway, Carello, BABY HOOD, More, Babyauto, KindComfort, Vivitta, BQS, Baby Quality Safe, 5dot, Babypack, Real Sociedad FC, Athletic Club deBilbao, OMP, OMP Pro Kids, Babybus, Babygab, Autozone, Autoreisen, Cicar, Galzerano, Infancia, Iobimbo, Midas, Rokko, Shears, Texbaby, Motortown, Unit, BBest, Masterbaby, Titanium Baby, Bebylux, SNAPKIS, Pilsan, Bebe Stars, Picardo, Chelino, Bambino, baby company, Mondial Safe, Fresh baby, INNOVACIONES M.S.S.L, PLAY, CASUALPLAY, PLAYXTREM, Be cool, Nurse, Kidscool, BBPRO, Lionel, Babyton, Mille, YOYKO, Safety 1st, Cosco, Infanti, 4X4, AUTO STYLE, ARRUE, AYABABY, ASALVO, AVANTI, BEBE9, BEBE9 EXPERT, BERTONNE, BABY LEE, BABYDESIGN, BABY ELEGANCE, BOMIKO, BABY POINT, BEBEQO, B&BABYBUS, BABY 1st, BABY ONE, B01, BABYHIT, BABY DIREKT, BYBERIT, BEBESEGUTO, BEBEDUE, BEBETON, BUDDY, CARBINO, COOL KIDS, CHIPOLINO, CONECO, DIVICAR, AHS BABY, DUMBO, EUROBIMBO, FAIR GO, FOPPAPEDRETTI, FIBERO, FISHER DESIGN, FORMULA BABY, FD DESIGN, HABERKORN, CLASSIC, I BABY, IO BIMBO JUNIOR, JUNIORS, JETEM, JOYELLO BIMBI IN ITALY, KINDERKRAFT, KIDDCARE, KOOL TRADE, KOML KIDS II, KU-KU DUCKBIL, LILLY&MARC, LAMA, LAPSI, Artman Baby, LUCKYSTAR, LADITO, LECOCOBABY, LOVE WORLD, MOTHER BABY, MONITRADE, MEE MEE, MAMAMAIBABY, MY CHILD, MARS DESIGN, NICE IDEAS, OBABY, PREMAMAN, PHIL&TED, PIERRE CARDIN PARIS, PIERRECARDIN ENFANTS, POPART, PUKU, RED KITE, SUPER NANNY, SUNNYLOVE, SEE BABY, TITYWORLD, TOP MARK, TOYS R US. TRILLE, TRULO ISRAEL, TOURAGOO, TONYBEAR, X-TREME BABY, X ADVENTURE, ZEKIWA, ZOOOPER, BABY MONSTERS, Baby Kit's, COSATTO, Pierre Cardin, KANZ, fairgo, BABYELLE, just baby, SAFECRUISE, baby&plus, BebeFeliz, Kraft, Am Steps, Kraft Baby, Sun Baby, Breton, Moresis, Baciuzzi, Baby Max, o3 baby, Peg-Perego, Foxbox, BestKids, Smart Baby, DHSbaby, BabyStar, MULTILASER, MULTIKIDS BABY, WEEGO, FISHER PRICE, Cangaroo, TOLKIR S.A., Lorelli, Nula Baby, Baby Smile, berton, Quinton, PICO, BB Design, AVtoKid, Kenga, DetOptom, Bebe Concept, Avigo, ECOBEBE, Marko, VIVA, Summer Baby, Little Bru, Republica Bebe, Interbaby, Mossa, Prebebe, LAVA Baby, Escos, KEENZ, BellaBaby, Angies, Angies Baby Shop, Zamboo, Diago, MAREMI, Kenstar, MamaLoes, Elele Baby, EMPEROR, Infanzia, Best Buying Service B.V., Koala, Safety 1st, PREMIUM BABY, ROYAL KIDDY, MY DEAR, MOLHO, MOLCHO, Emperor Baby, Joker, FreeON, P'tit, Giordani, Koala, k-junior, Picolo, Avalon, Noola, be cool, Osann, baby nurse, Harmony, Cuggl, Halfords, Mothercare, Elele, Infanti, LAVA, Babylo, Infasafe, Infasecure, Giggles, clamaro, tuctuc, Axonkids, little king, Britton, fairworld, Fedora, LEWIS, Infasafe, Infasecure, mini panda, For kiddy, crolla, ubaby, OTOMO, Nebio, Huggy, EMBIX, CAMERA, HONOVii, LEAMAN, APOLLO, VOITEK, TODBI, Carestino, Blij'r, baby tilly, kiko, brevi, bexa, Estella, Fedora, Wish Kids, Burigotto, Peg perego, Roking Baby, Baby ECO, babyOline, 1st Step, KidStar, Sirocco, Mimosa, Loveamme, Carbebe, Twist, Derform, Kindah, Baby Africa Sport Line, Grand, akeeva, beblum, Avora, Oods, Nistulgrow, XOMAX, Ding, Kiddy, beana, chicco, Avina, cooper, GLOWY STAR, Galaxy, Babymichel, daly, rant, coletto, bebe2lux, stilotex, quinton, Advance, Galzerano, Pali, Bliva, Infababy, Cool Baby, Neeto, Baryli, Baby Bear Origin, mini uno, Little bambino, Priori, FOPPAPEDRETTI, bium, MY BABY, XADVENTURE, interchild, BaryB, Turner, STAR IBABYHEYNER®, capsula®, CREW, BABY LOVE, APRUVA, Beanie, Mondial, Mamico, LEGACY, NUOVITA, FICO, FUN N, U-BABY PRO, CROCODILE, SONGJOU, Bonio, Mother Baby, Miophy, FORTIS, Pikkaloo, Smart Mommy, El Camino, SESTTINO, SESTTINO KIDS, BEBE9, FM Service, Babyton, Mille, Aubert,

Yangzhou Lettas Baby Product Co., Ltd.	Type: T005F
	ID No.: 129-T005F-01
	Date: 2023-11-14
	Page 4 of 29

Orchestra, Juniors, Aubert Concept, Formula Baby, William Kent 1733, HAUCK, NEENEE, TuttoReecle, Carrello, Kids Zone, Bonito, spacehd, Zopa, Baby Direkt, Intan Kids, baby monsters, MINANA, SIDLO, coccolle, Norauto, ABC DESIGN, Bébéconfort, Babidéal, Baby relax, Monbébé, ATU, Carter Cash, Mobivia, Synchro diffusion, mipies, Midas, zoalfer, minimondo, babygo, skiddou, MANDY, MAXMA, LITET, DAIICHI, Babify, 两只兔子, bunny too, zaracos, Halfords, Prinsel, the pud store, cam, liko baby, Nohro, KIDIZ, Apidae, Bebe Confort, BBGO, Kiddy, Mora ferre, Uber Kids, MAMA KIDDIES, TelForceOne S.A, ickle bubba, E.g. Qute, Kidsriver, Dubatti, We-Too, Puck, more, Lettas, bonio, HAPPY YOOTU BABY, 适优途, KIKKABOO, VOYAGE, amarobaby, MIMOSA, KLEE, banana, glowy star, glowy, BUBAGO, AMAROBABY, AMAROKIDS, KLEE, Cocolatte, BABYDOES, baby-dump, timgro, Bonfino, Caring Star, Street Racer, phil&teds, mountain buggy, Bellino, E.g.Qute, Kidsriver, Dubatti, We-Too, Puck, KLEE, babyauto, Bbest, Cicar, Fairgo, **KLEE, b.bee, Martin noir, Sevilababy, casa tomara, bbee, cavalo, Deborn, kikkaboo, Ecom, nanoobaby, skyview, litter rider, odkryj-auto, phil&teds, RETRUS COLETTI, Momi, EURO CART, RIKO, CAVOE, COLIBRO, EASY-GO, bonitocoSTE, fortebebe, TM Sweet Baby, miniuno, Silver Fox, abra meble, litter rider, odkryj-auto, MoMi, LittlesGo, my junior, Babygab, Happy Bear, ZY (Zippy Safe), Motortown, Cicar, Norauto, Midas, Bounce, Lova, Orvecame, ebebek baby plus, babyone, miniuno, niu, abra meble, phil&teds, MoMi, sparco, OLMITOS, APOLLO, My babiie, LittlesGo, EDIESI, OLMITOS, NIU, SPARCO(SK100I), SPARCO KIDS(SK100KI), bbee, nanoobaby, G&P, NOVI baby, i-Go, i-Tip, i-Boost, Silver Fox, abra meble, ebebek baby plus**

- 0.2. Type: T005F
- 0.2.1. Commercial description(s): MandyPro, **Elio, SPARCO(SK100I), SPARCO KIDS(SK100KI)**
- 0.2.2. Variant(s): T005F, **T005F Pro**
- 0.5. Name and address of manufacturer: Yangzhou Lettas Baby Product Co., Ltd.
Jianhua Village, Hanjiang District,
Yangzhou City, Jiangsu Province, P.R.
China
- 0.7. In the case of components and separate technical units, location and method of affixing of ECE approval mark: Sticker pasted on the bottom of base
- 0.8. Address(es) of assembly plant(s): See 0.5.
- 0.9. Name and address of manufacturer's representative: n.a.

1. TECHNICAL DESCRIPTION

- 1.1. ECRS category: Universal booster cushion
- 1.2. ECRS class: Non-integral, Booster cushion
- 1.3. Size Range: 125-150cm
- 1.4. The maximum occupant mass allowed for Integral ECRS: n.a.
- 1.5. ECRS orientation: Forward facing
- 1.6. Anti-rotation device: n.a













Yangzhou Lettas Baby Product Co., Ltd.	Type: T005F
	ID No.: 129-T005F-01
	Date: 2023-11-14
	Page 5 of 29

- | | | |
|-------|--|---|
| 1.7. | Child Restraint Mode: | adult safety-belt |
| 1.8. | Locking-off device type: | n.a. |
| 1.9. | Type of retractor: | n.a. |
| 1.10. | Belt type: | adult safety-belt |
| 1.11. | Other features: | Booster cushion |
| 1.12. | Mass of the complete CRS: | 1.9 ± 0.5 kg |
| 1.13. | Installation method: | 125-150cm: adult safety-belt + ISOFIX attachments;
125-150cm: adult safety-belt |
| 1.14. | Backrest positions: | n.a |
| 1.15. | Drawings, diagrams and markings of the ECRS, including all its relevant parts: | See Appendix 1, BOM LIST and Drawings |
| 1.16. | Declaration on toxicity in accordance with Paragraph 6.3.1.1. of UN R129.03: | See Appendix 3, Declaration on the toxicity and flammability of used materials |
| 1.17. | Declaration on flammability in accordance with Paragraph 6.3.1.2. of UN R129.03: | See Appendix 3, Declaration on the toxicity and flammability of used materials |
| 1.18. | Instruction for use of ECRS in the vehicle: | See Appendix 2, Labels;
See Appendix 4, Manufacturer's instruction manual;
See Appendix 5, Packing Info |



Yangzhou Lettas Baby Product Co., Ltd.	Type: T005F
	ID No.: 129-T005F-01
	Date: 2023-11-14
	Page 6 of 29

Appendix 1: BOM LIST and Drawings
- BOM LIST (Key Components)

No.	Picture	Name	Spec. /material	Manufacturer	DWG No.	Remark	
1		T005F Base	PP-K8003 (black/white)	Yangzhou Lettas Baby Product Co., Ltd.	T005F-2P00-001	For T005F and T005F Pro	
2		T005 base EPS	EPS	Hongcheng packaging materials Taizhou Co., Ltd	T005-2S00-001		
3		T005 armrest EPS (L/R)	EPS	Hongcheng packaging materials Taizhou Co., Ltd	T005-2S00-002		
4		T005-FIX Upper fixing plate (L/R)	Q235	Taixing Yufu metal products factory	T005-2M00-001		
5		T005-FIX Lower fixing plate	Q235	Taixing Yufu metal products factory	T005-2M00-002		
6		5# ISOFIX assembly (L/R)	-	Zhenjiang Meiluo Electronics Co., Ltd	000-2A00-134		
7		Green vehicle belt clip	POM	Changzhou Mino precision mould Co., Ltd	T003-2P00-003		
8		T003 clip belt	-	Wuxi Jinma Weaving Co., Ltd.	T003-2A00-002		
9		A23 Cup holder	PP-K8003	Nanjing Jiangning District Guoyin Plastic Factory	A23-2P00-001		
10		T005 waist cushion (optional)	PP-K8003 (black/white)	Yangzhou Lettas Baby Product Co., Ltd.	T005-2P00-003		For T005F
11		T005-2# waist cushion	PP-K8003	Yangzhou Lettas Baby Product Co., Ltd.	T005-2P00-004		For T005F Pro



- Drawings

No. LTS-T005F-ASM, T005F Assembly

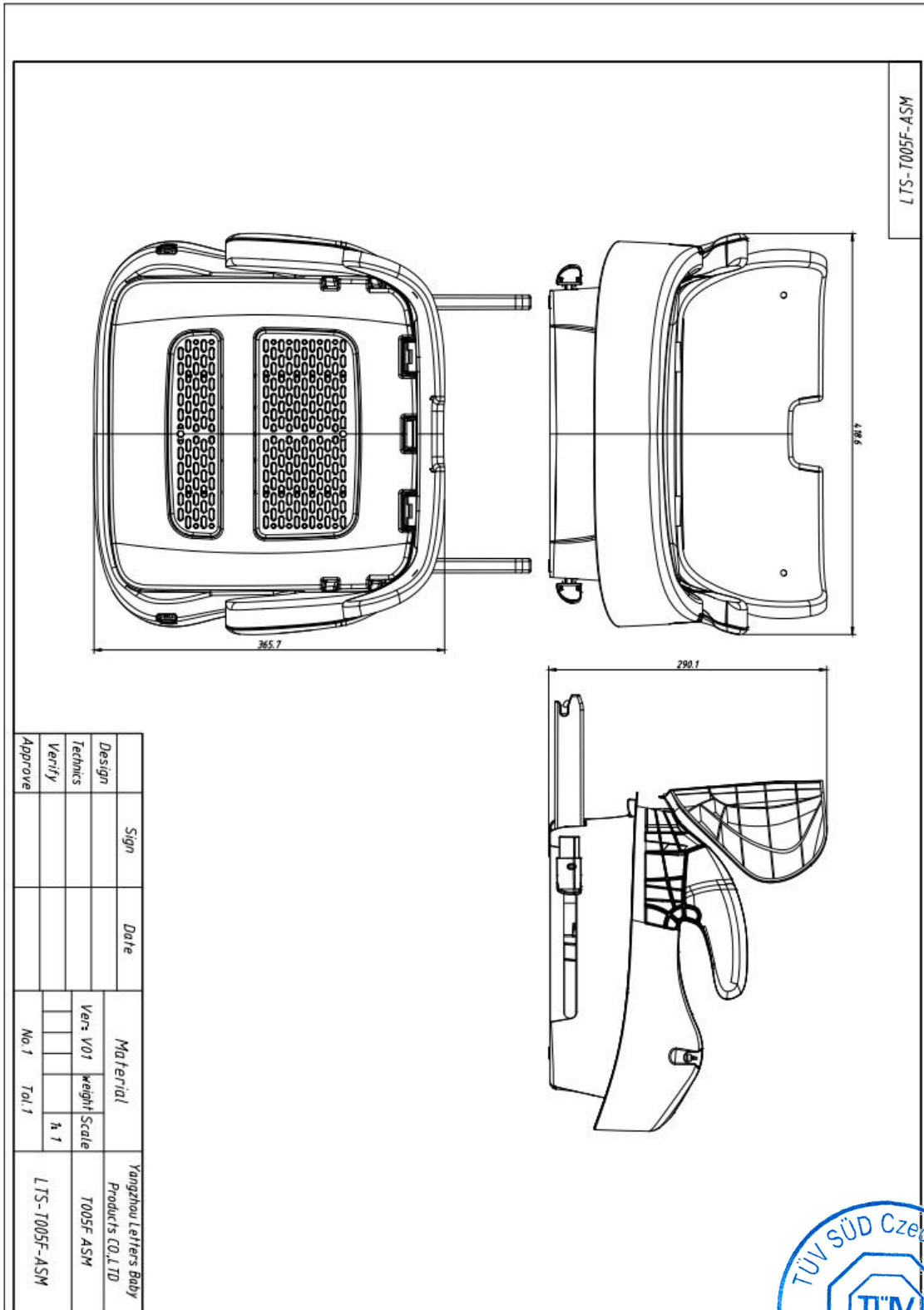

Design	Sign	Date	Material		Yangzhou Lettas Baby Products CO.,LTD
Technics			Ver. V01	Weight Scale	
Verify				h 1	
Approve			No. 1	Tal. 1	
					LTS-T005F-ASM

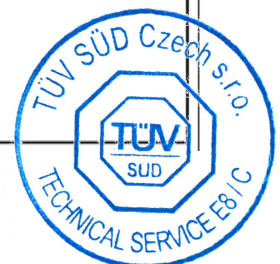

No. LTS-T005F PRO-ASM, T005F PRO Assembly

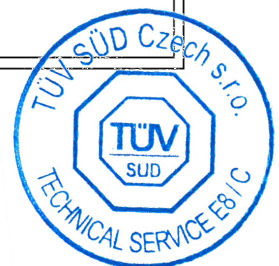
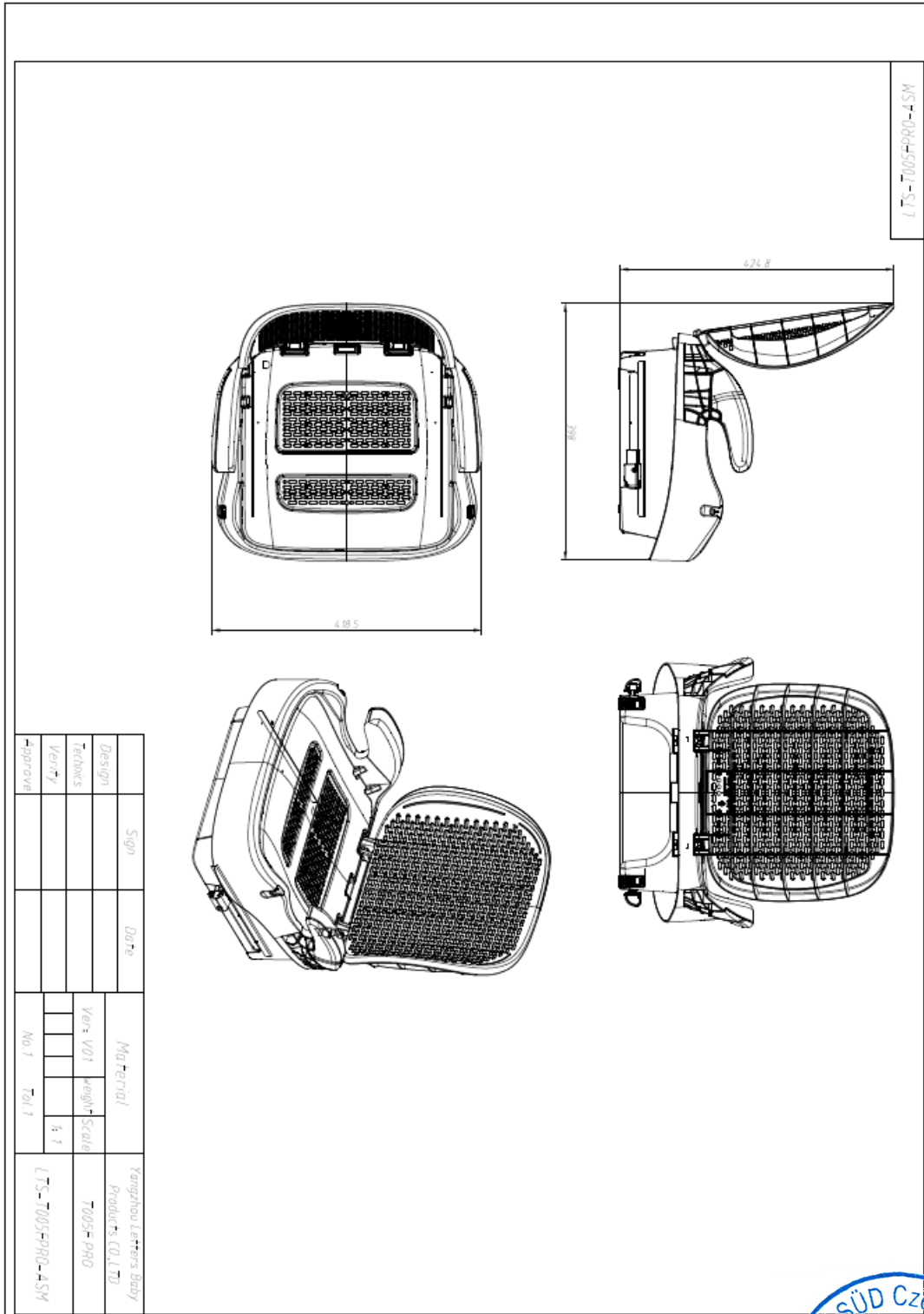

No. LTS-T005F-EXP, T005F Explosive

LTS-T005F-EXP

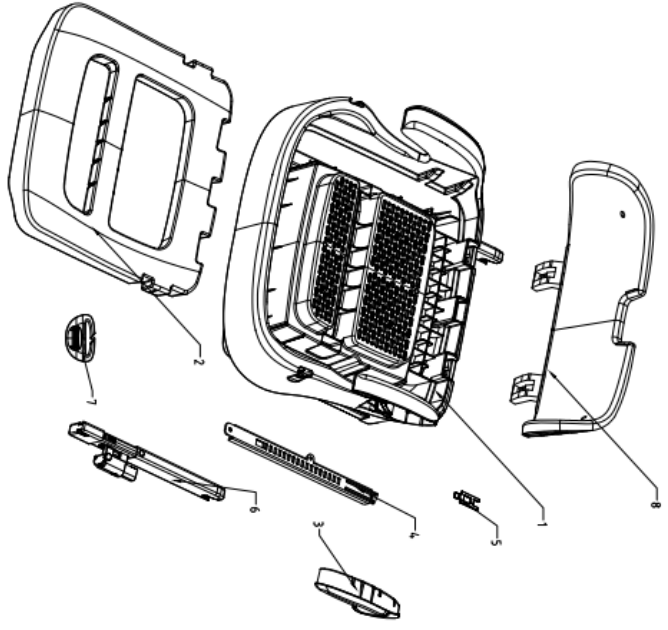

NO.	NAME	DWG NO.	NUM.	MATERIAL
8	T005 seat cushion	T005-2P00-003	1	PP-K8003
7	T003securing clip	T003-2P00-003	1	POM
6	Shoulder strap U/R	000-2A00-134L/R	each 1	
5	T005-2X000-002 Shoulder strap plate U/R	T005-2M00-002	2	0235
4	T005valiper flange plate U/R	T005-2M00-001L/R	each 1	0235
3	T005 base EPS	T005-2S00-002L/R	each 1	EPS
2	T005F base EPS	T005-2S00-001	1	EPS
1	T005F base	T005-2P00-001	1	PP-K8003

Design	Sign	Date	Material	Weight	Scale	Yanzhou Lettas Baby Products CO.,LTD
Verify					1/5	
Approve						

No. 1	Tol. 1

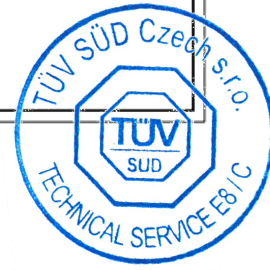

No. LTS-T005F PRO-EXP, T005F PRO Explosive

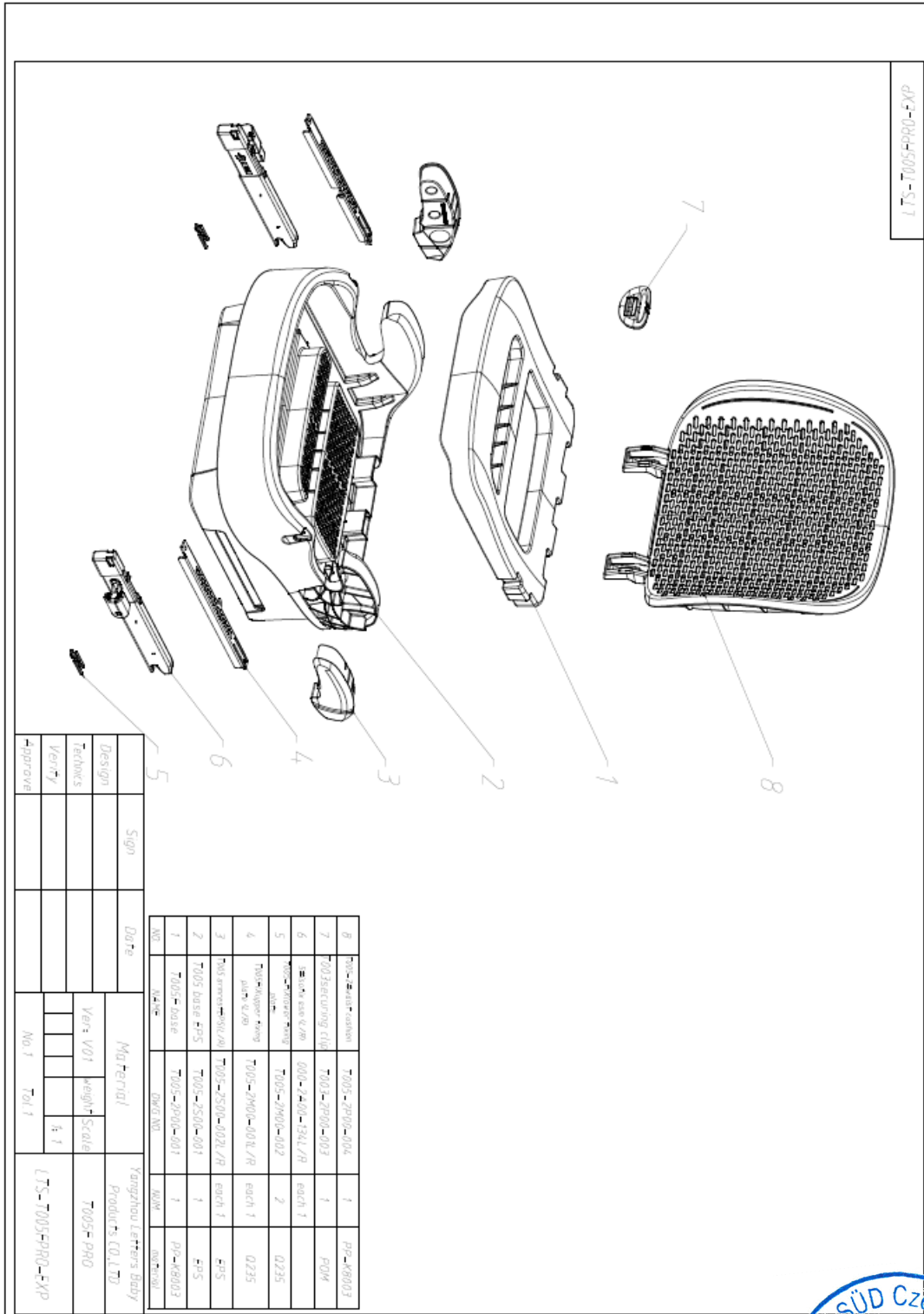

LTS-T005FPRO-EXP

Design	Sign	Date	Material	Yangzhou Lettas Baby Product Co., Ltd.
Technics			Ver: V01	Product: T005F PRO
Verify			Scale	4:1
Approve			No. 1	T01.1

NO.	NAME	QTY	UNIT	REMARK
1	T005 base	1	PCS	PP-A48003
2	T005 base FPS	1	PCS	
3	T005 base FPS	1	PCS	
4	T005 base FPS	1	PCS	
5	T005 base FPS	1	PCS	
6	T005 base FPS	1	PCS	
7	T005 base FPS	1	PCS	
8	T005 base FPS	1	PCS	

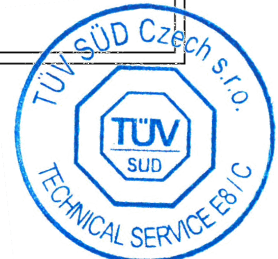

No. T005F size envelope

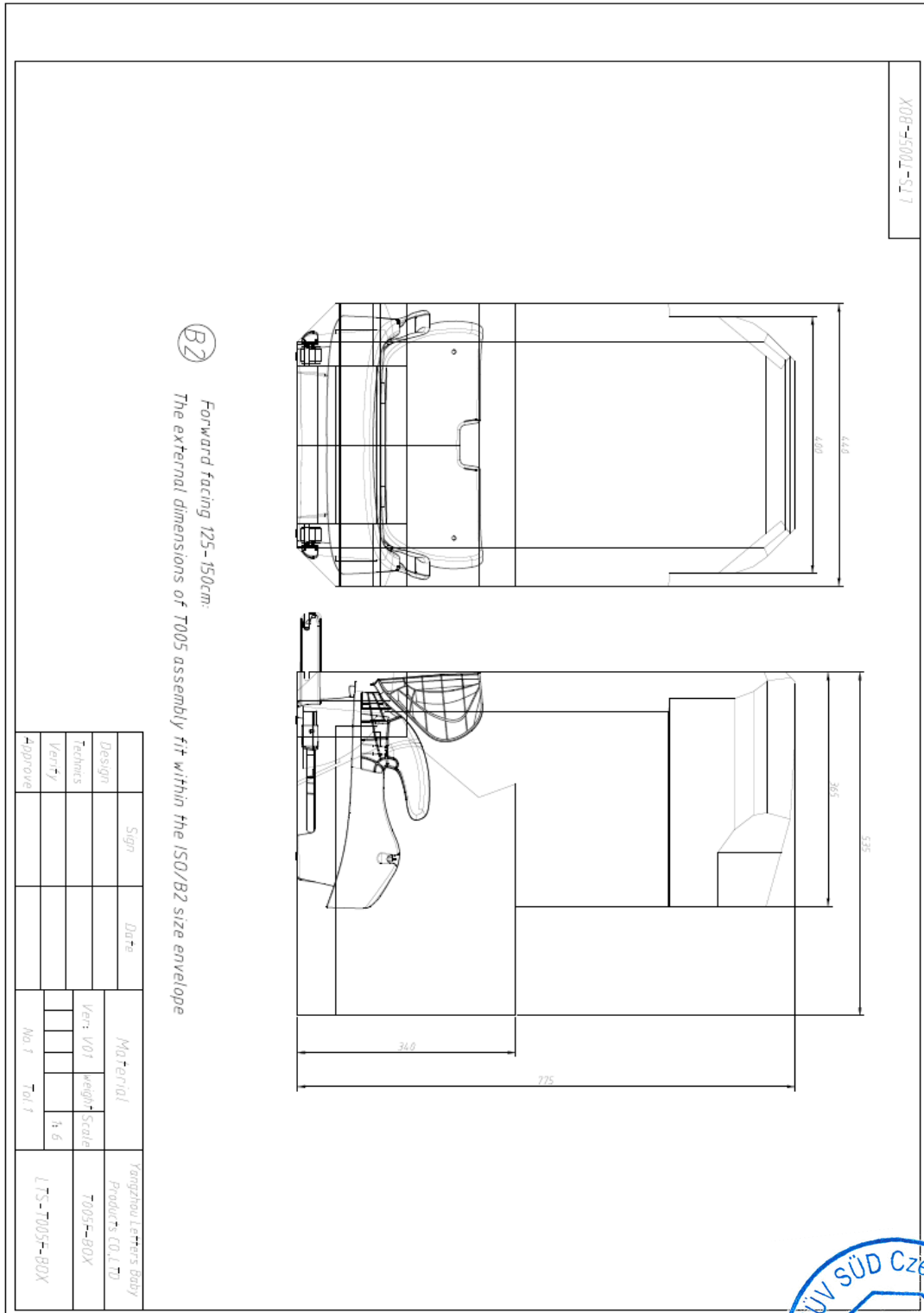

No. T005F PRO size envelope

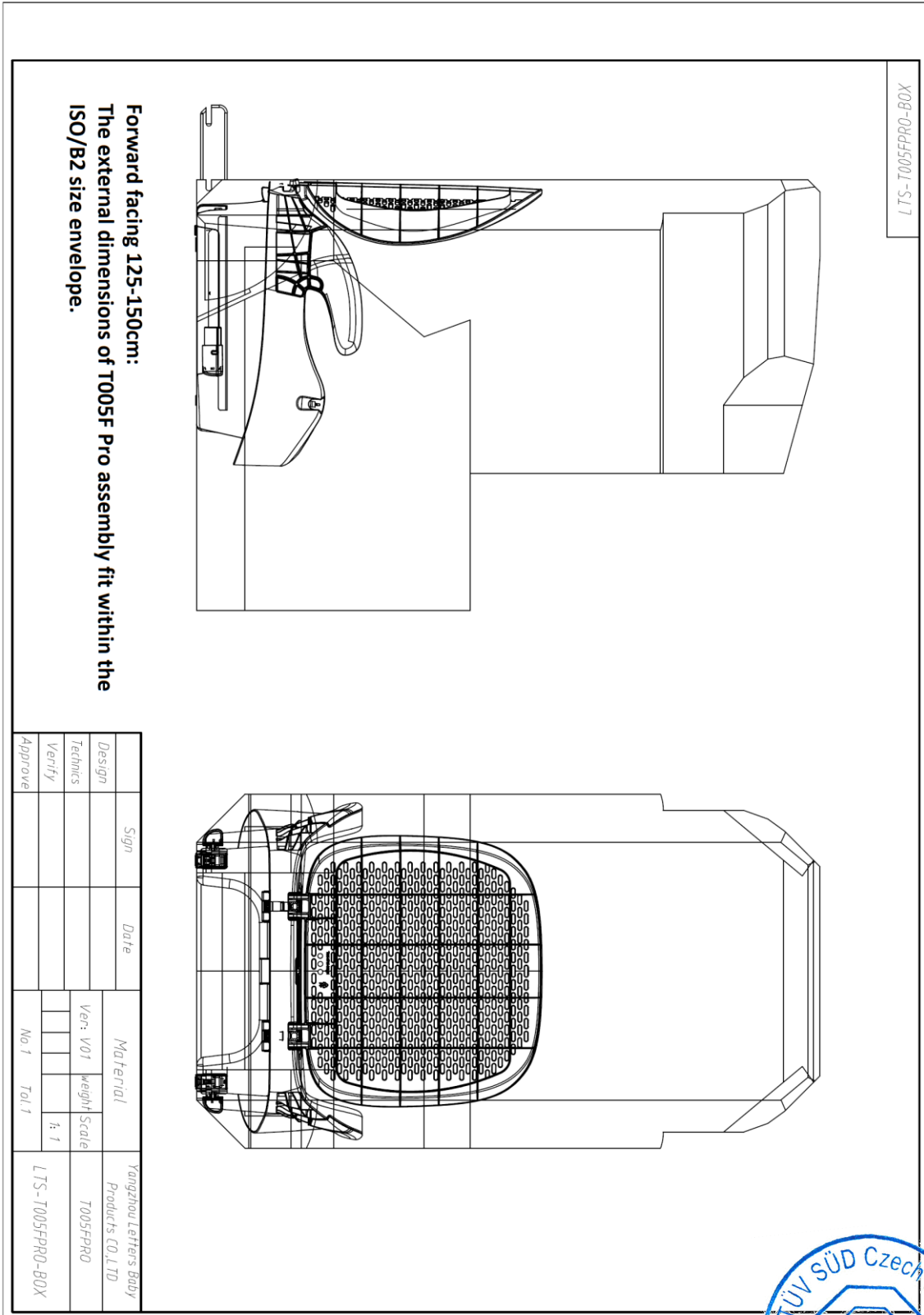

No. T005-2S00-001, T005 base EPS

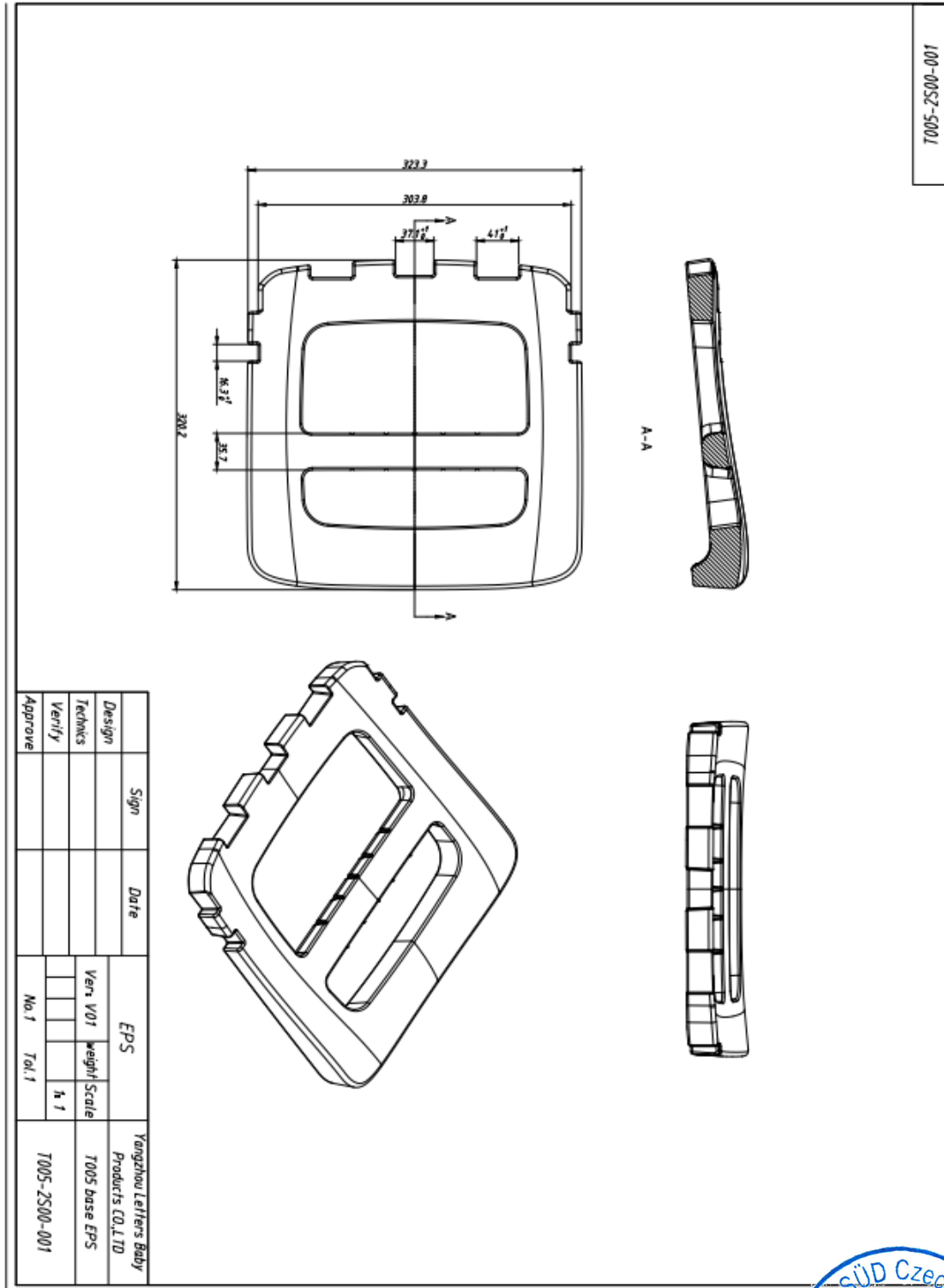

Design	Sign	Date	EPS		Yangzhou Lettas Baby Products CO.,LTD
Technics			Vers V01	weight Scale	T005 base EPS
Verify			No. 1	h. 1	
Approve			Tol. 1		T005-2S00-001

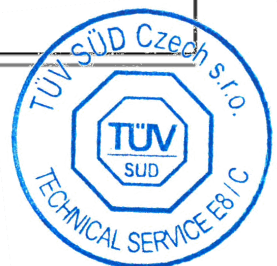

No. T005-2S00-002, T005 armrest EPS(L/R)

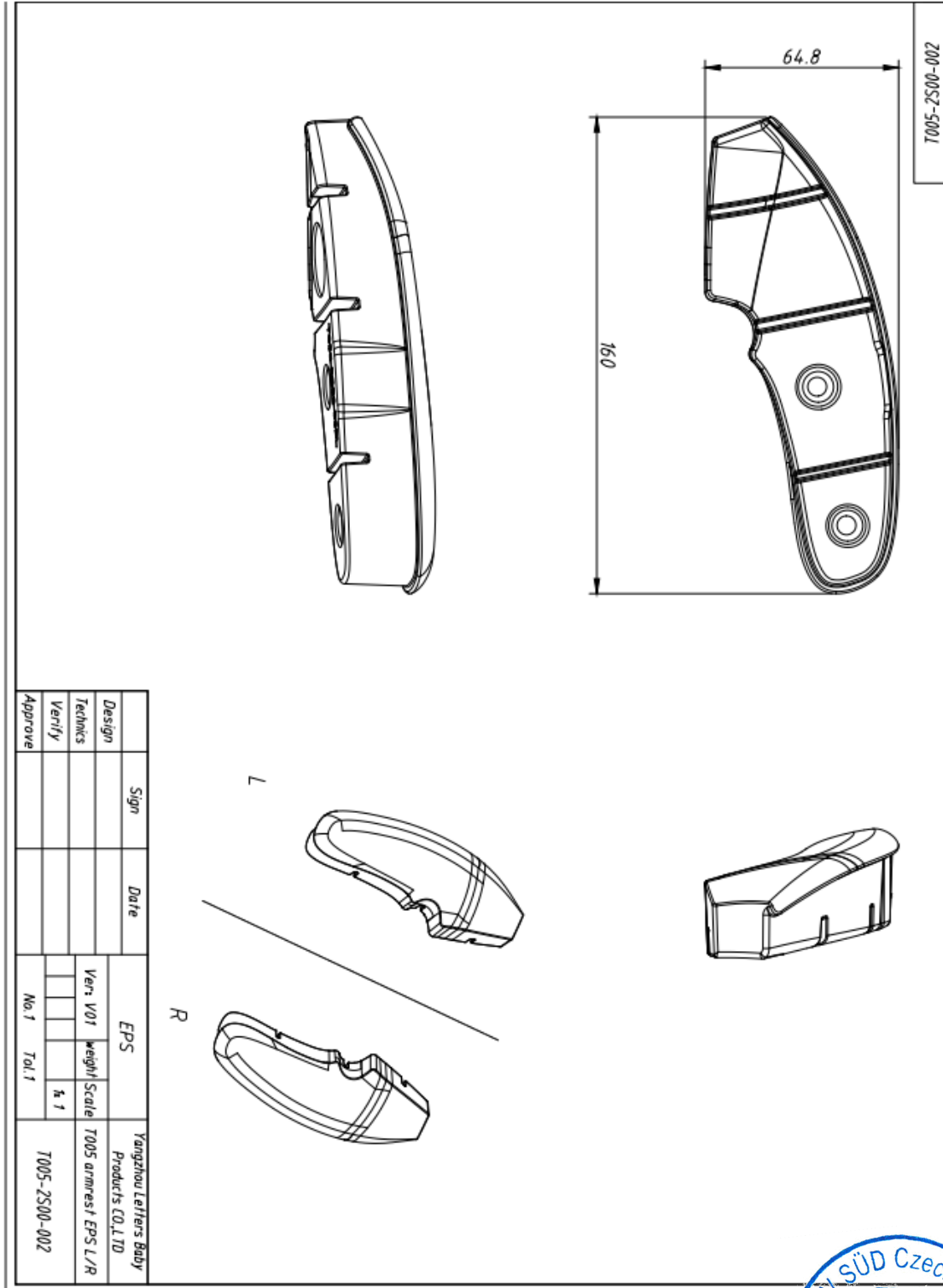

No. T005-2M00-002, T005-FIX Lower fixing plate

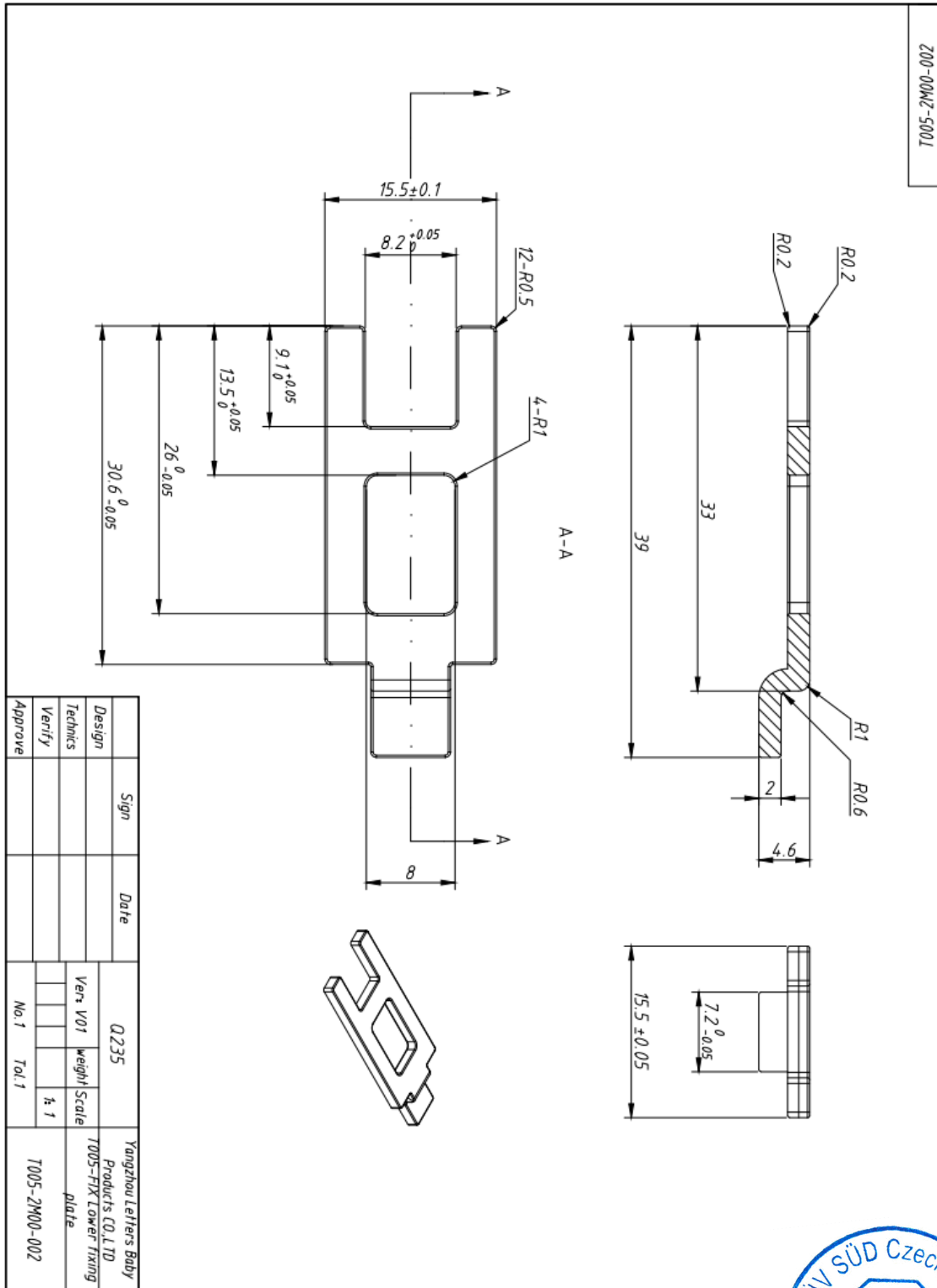

No. 000-2A00-134, 5# ISOFIX assembly

7#E1-00#Z-000

Item	NAME	DWG number	Quantity	material
18	001-2M00-031	screw	1	carbon steel
19	000-2M00-087	2#Fix rivet	1	Q235
18	000-2P00-024L	2#Fix secondary lock (R)	1	PC-365
17	000-2M00-024	2#Fix spring	1	65Mn
16	000-2P00-022L	2#Fix open cover (L)	1	PC-365
15	000-2P00-023L	2#Fix open button (L)	1	PC-365
14	000-2M00-089	4#Fix gear spring	1	65Mn
13	000-2M00-018	spring	1	65Mn
12	000-2M00-077	3#Fix spring	1	65Mn
11	000-2M00-072R	3#Fix side board (R)	1	SPCC
10	000-2M00-072L	pin	1	Q235
9	000-2M00-009	Fix locking piece	1	Q235
8	000-2M00-071	3#Fix locking block	1	45#
7	000-2M00-070	pin	2	Q235
6	000-2M00-020	2#Fix locking piece	2	45#
5	000-2P00-096	3#Fix back cover	1	PP-K8003
4	000-2M00-088	4#Fix gear locking piece	2	45#
3	000-2P00-025L	2#Fix fixed block (L)	1	PC-365
2	000-2M00-072L	3#Fix side board (L)	1	SPCC
1	000-2P00-095	3#Fix front cover	1	PP-K8003

no click when locking

Design	Sign	Date	
Technics			
Verify			
Approve			

Ver: V01	weight	Scale
		4:1
No. 1	Tot. 1	

Yangzhou Lettas Baby
Products CO., LTD

5#ISOFIX assembly

000-2A00-134L

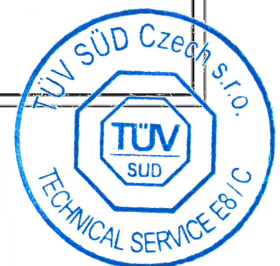

No. T003-2P00-003, Green vehicle belt clip

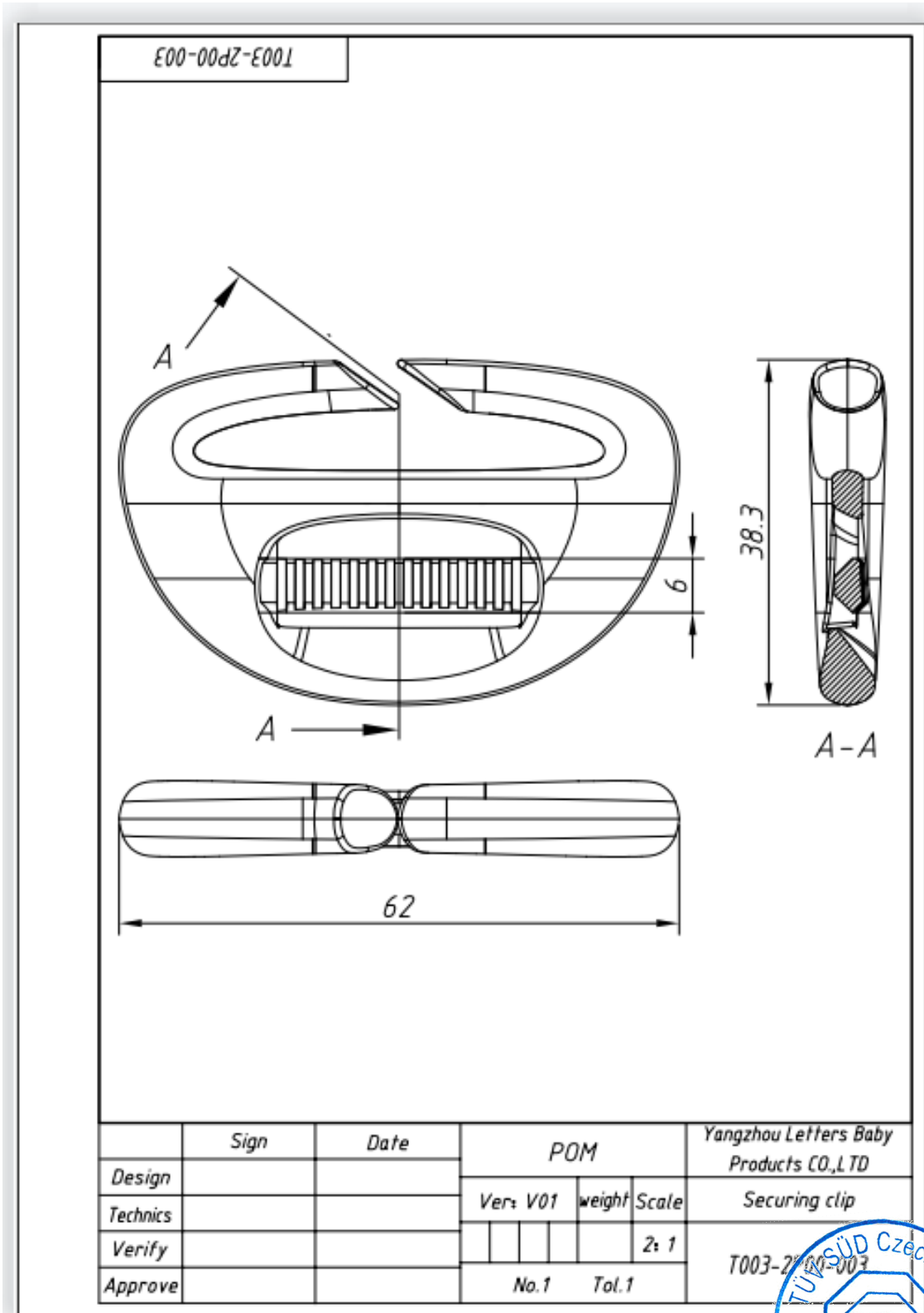

	Sign	Date	POM			Yangzhou Lettas Baby Products CO.,LTD
Design			Ver: V01	weight	Scale	Securing clip
Technics					2:1	
Verify						T003-2P00-003
Approve			No.1	Tol.1		

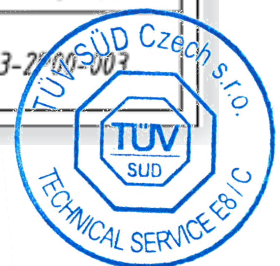

No. A23-2P00-001, A23 Cup holder

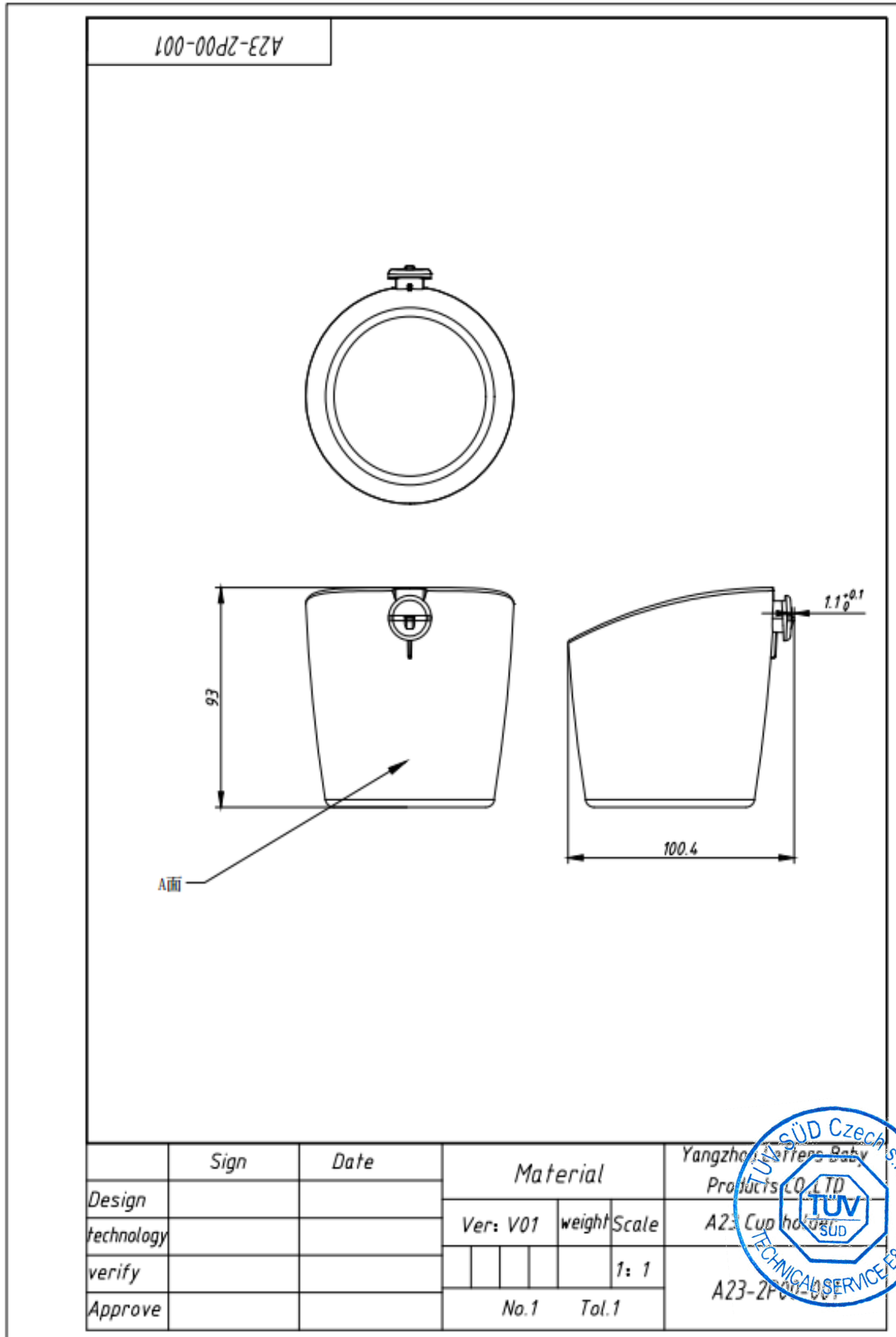

No. T005-2P00-003, T005 waist cushion (optional)

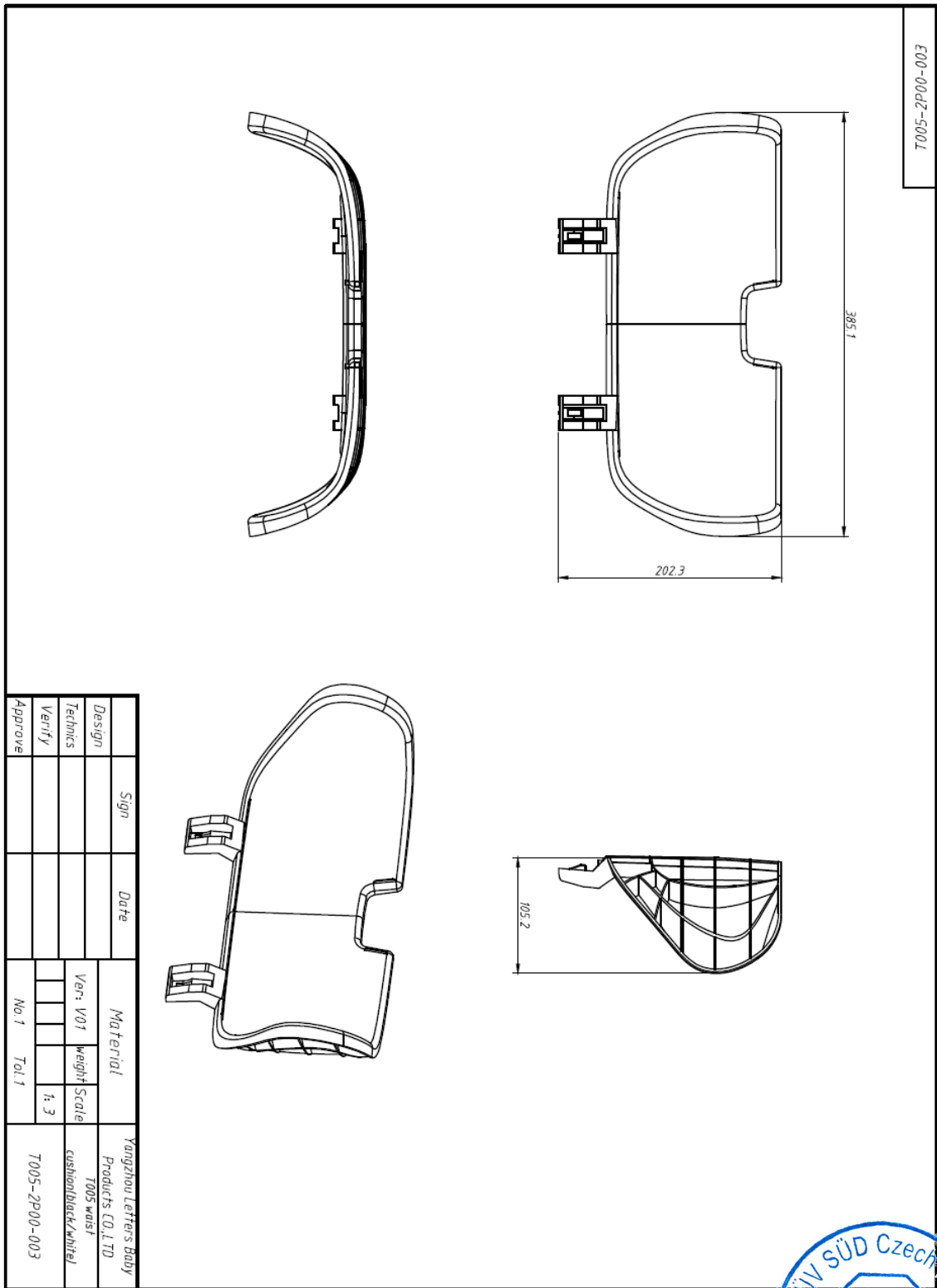

Design	Sign	Date	Material		Yangzhou Lettas Baby Products CO., LTD
			Ver: V01	Weight Scale	
Technics					
Verify					
Approve			No. 1	Tol: 1	T005-2P00-003
					cushion(black/white)



No. T005-2P00-004, T005-2# waist cushion

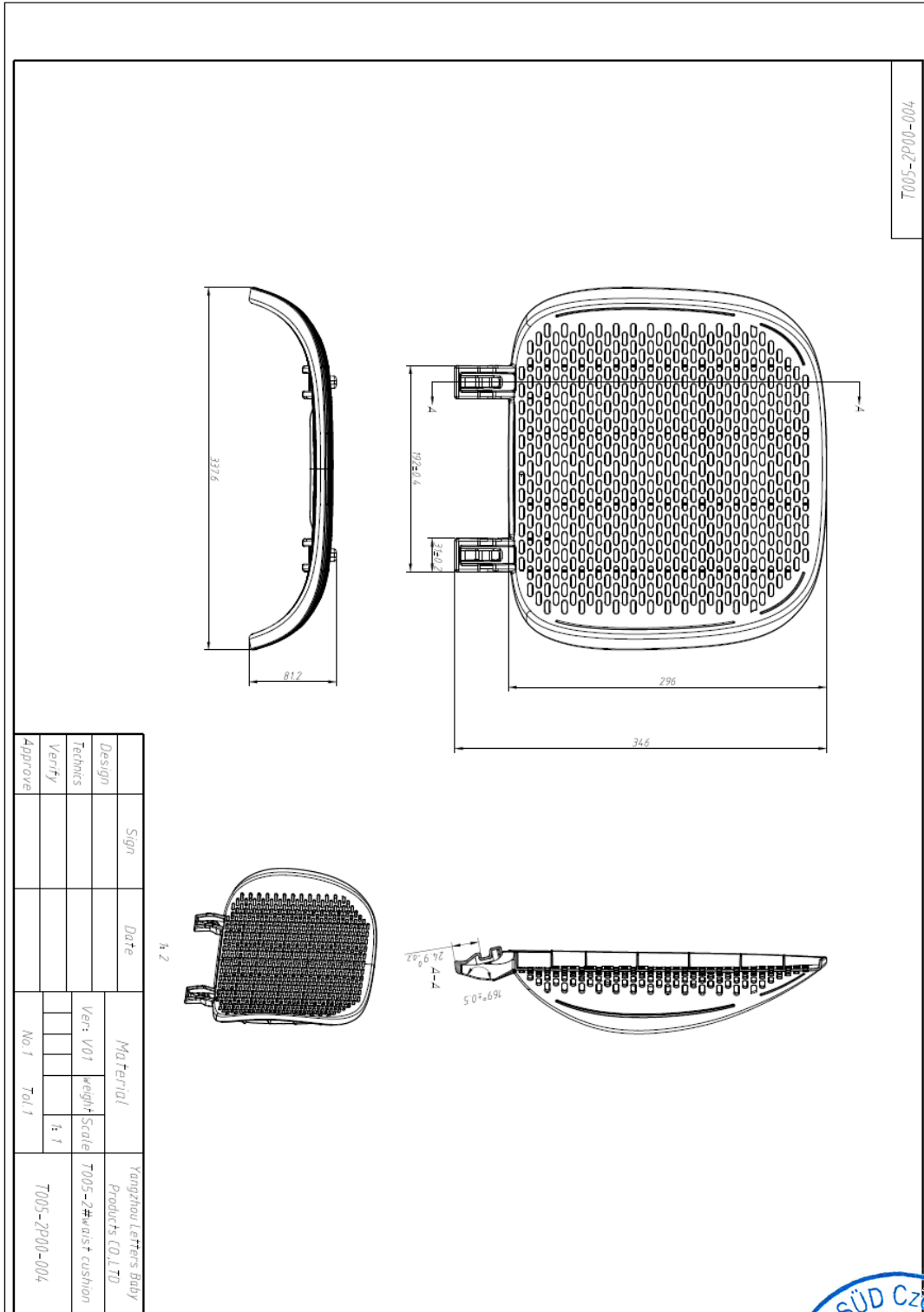

Design	Sign	Date	Material		Yangzhou Lettas Baby Products Co., Ltd.
Technics			Ver: V01	weight	
Verify				Scale	
Approve			No. 1	Tol: 1	
					T005-2P00-004

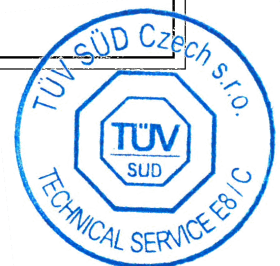

- Position of Plastic info, Installation Labels, and ECE approval markings

Location of plastic info.(Production date, Material, Recycling) marking:



Location of the Warning Labels, Installation Labels, Approval marking and the Instruction Manual:

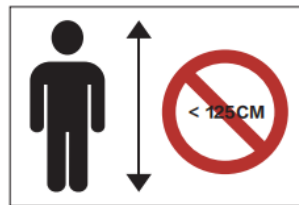

Location of Instruction Manual

Belt guide indication width: 50mm

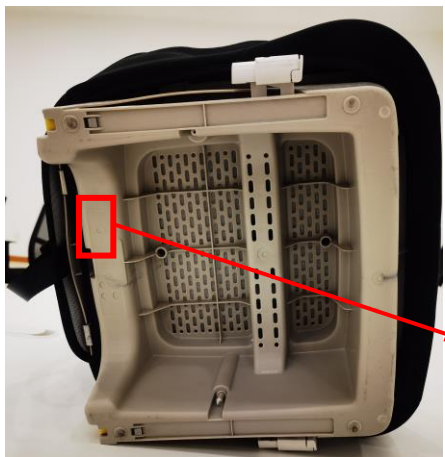
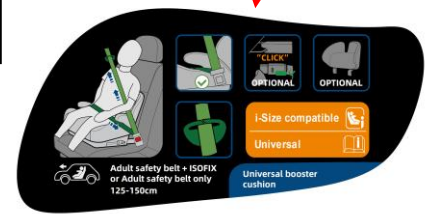

50mm



Yangzhou Lettas Baby Product Co., Ltd.	Type: T005F
	ID No.: 129-T005F-01
	Date: 2023-11-14
	Page 25 of 29

Appendix 2: Labels
-Installation Labels

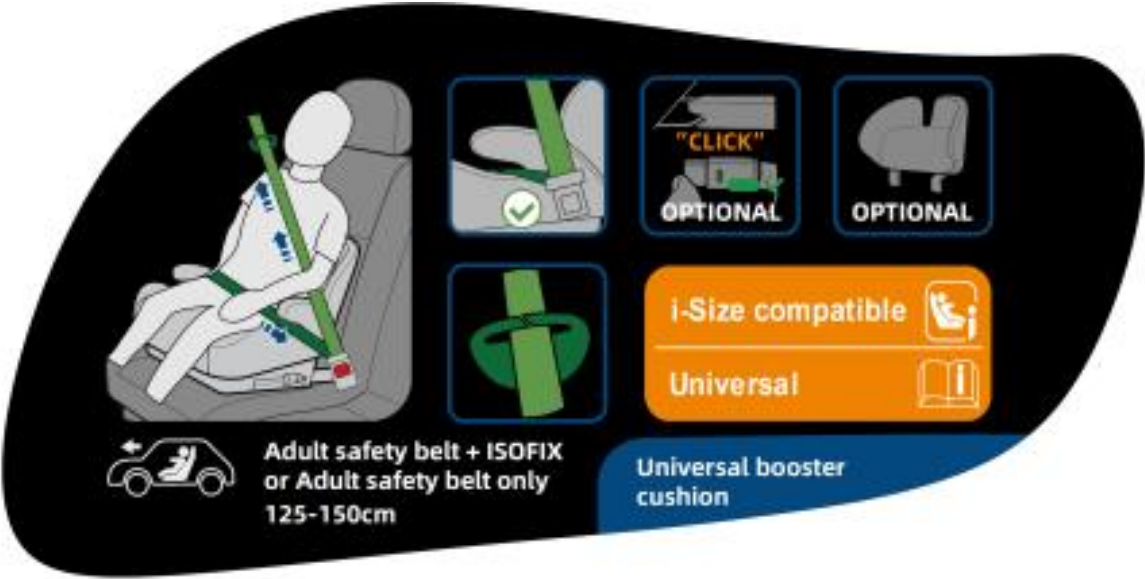

Yangzhou Lettas Baby Product Co., Ltd.	Type: T005F
	ID No.: 129-T005F-01
	Date: 2023-11-14
	Page 26 of 29

Appendix 3: Declaration on the toxicity and flammability of used materials

Statement Concerning the Toxicity and Flammability.

We hereby declare that the materials used to manufacture the enhanced child restraint system T005F are in conformity with the requirements of par. 6.3.1.1 and par. 6.3.1.2 in regulation UN R129.03 regarding to the toxicity and flammability.

Faithfully yours

Responsible person: YUTING WANG

Yangzhou Lettas Baby Product Co., Ltd.



Appendix 4: Manufacturer's instruction manual for use

MORE THAN SAFE!

YANGZHOU LETTAS BABY PRODUCT CO.,LTD
 TEL: +86 0514-80326558
 WEB:
 www.instagram.com/reebabycarseat
 reebaby.en.alibaba.com
 ADD:
 JIANHUA VILLAGE, HANJIANG DISTRICT,
 YANGZHOU CITY, JIANGSU PROVINCE, 225127, P.R. CHINA

Reebaby

T005F 125-150cm
 UNIVERSAL BOOSTER CUSHION
 Waist Cushion (optional)

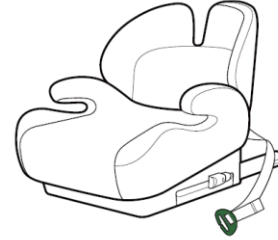

STRUCTURE NAME

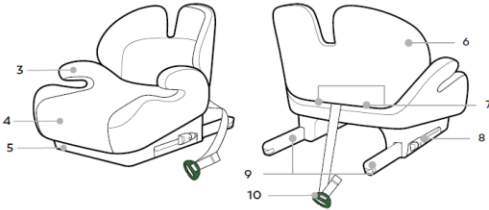

- 1 ISOFIX Insertion Aids (vehicle)
- 2 ISOFIX Fastening Points (vehicle)
- 3 Armrests
- 4 Seat Cover
- 5 Base
- 6 Waist Cushion (optional)
- 7 Release Buttons
- 8 ISOFIX Buttons
- 9 ISOFIX Locking Arms
- 10 Vehicle Belt Clip
- 11 Seat Cover R-elf



01

02

INSTALLATION

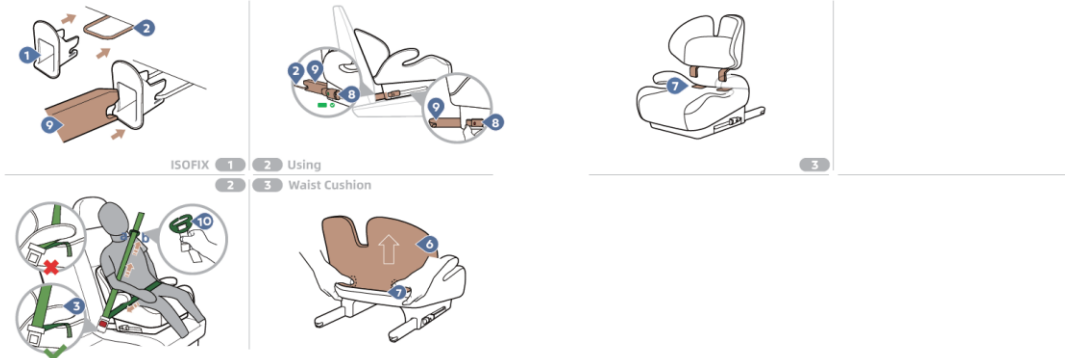

03

04

APPROVAL

These instructions use the following symbols:

Symbol	Keyword	Explanation
⚠	DANGER!	RISK of severe personal injury
⚠	WARNING!	RISK of minor personal injury
⚠	CAUTION!	RISK of material damage
ℹ	TIP!	Useful notes

The T005F is exclusively intended to secure your child in your vehicle.

Tested and approved according to ECE R129		
Body size	Installation method	Installation direction
125-150cm	Belt+Isofix	Facing forwards
	Belt	Facing forwards

*ECE=European Standard for Child Safety Equipment
 The child safety seat has been designed, tested and approved according to the requirements of the European Standard for Child Safety Equipment (ECE R129/03).

The seal of approval "E" (in a circle) and the approval number are located on the orange approval label (sticker on the child safety seat).

⚠ DANGER! This certification will be invalidated if you make any modifications to the child safety seat. Only the manufacturer is permitted to make modifications to the child safety seat. Unauthorised technical changes can cause the protective function of the seat to be reduced or completely eliminated. Do not make any technical changes to the child safety seat.

⚠ DANGER! Use the T005F UNIVERSAL BOOSTER CUSHION exclusively for securing your child in your vehicle. It is in no way suitable for using as a seat or toy at home.

USE IN THE VEHICLE

Please refer to the vehicle handbook information about vehicle seats which are certified for the use of children's restraining systems according to ECE R16.

During use, be sure to observe any restrictions relating to airbags.

You can use your child safety seat as follows:

Facing forwards (in the direction of travel)	Yes
With 2-point safety belt	No
With 3-point safety belt	Yes
On seats featuring: ISOFIX fastenings	Yes



When using as universal booster CUSHION (125-150cm). This ECRS is suitable for seat belt models equipped with the 3-point seat belts that has passed the ECE R16 requirement and is not suitable for models only equipped with 2-point seat belts.

1. Facing forwards (in the direction of travel) on passenger airbags (side-impact passenger seat backwards and any other directions in your vehicle). Please ensure that the airbag is deactivated.
 (Please observe the applicable regulation in force in your country.)



05

06

ISOFIX

1.If your vehicle is fitted with **ISOFIX Insertion Aids (1)** as standard, clamp the two **ISOFIX Insertion Aids (1)**, which are included in the scope of delivery of the seat, with the opening pointing upwards, to the two **ISOFIX Fastening Points (2)** of your vehicle.

TIP! The ISOFIX fastening points are located between the surface and the backrest of the vehicle seat.

2.Press the **ISOFIX Buttons (3)** to push out the two **ISOFIX Locking Arms (4)** from the seat base.

3.Push back the child safety seat until the child safety seat is firmly against the vehicle seat then you hear a clicking sound which indicates they are fully engaged. And on both sides of the ISOFIX indicator turn in to green safety color.

4.Move the child safety seat backwards and push the **Waist Cushion (5)** against the vehicle seat.

TIP! Release button towards each other to loosen the ISOFIX fastening point on both sides. Move the ISOFIX locking arms back into the seat base, it can protect ISOFIX.

Using

ISOFIX+Adult safety-belt or Adult safety-belt only.

1.Place the universal booster cushion on the vehicle seat.

If you don't have ISOFIX, please ignore this Step. Install the universal booster cushion with the vehicle belt.

2.Let's the child in the universal booster cushion. Pull out the belt from the belt ALR (Automatic Locking Retractor).

3.Guide the diagonal belt into the **Vehicle Belt Clip (10)** as shown, please guide the diagonal belt into it, and adjust the length of the strap to make the diagonal belt slightly higher than the child's shoulder. When fasten the vehicle belt, making sure the lap belt passes under both **Armrests (9)**, while the diagonal belt is above the armrest.

TIP! Keep the diagonal belt at the position of belt guidance between the outside of the neck and shoulder (in the middle of point a and point b).

WARNING! The vehicle belt must not be twisted or have their places changed over.

Pull the strap, adjust the height of the **Vehicle Belt Clip (10)** to adapt to children of different heights.

TIP! The importance of ensuring that any lap vehicle seat belt is worn low down, so that the pelvis is firmly engaged, shall be stressed.

Lock the tip of the buckle into the vehicle seat buckle with a clicking sound. Follow the direction of arrow to tighten belt, and put redundant belt into ALR. Shake the child safety seat to make sure it is securely attached.

TIP! The diagonal vehicle seat belt section must run diagonally backward. You can adjust the course of the belt with your vehicle's ALR on both sides.

Waist Cushion

1.Raise the **Waist Cushion (5)** at 90 degree angle. Insert the two plastic tongues of the **Waist Cushion (5)** back to the connection hole of the base.

2.If you want to separate them, press the **Release Button (7)** by your finger.

Whether you remove the **Waist Cushion (5)** or not, using method is the same.

If you don't have **Waist Cushion (5)**, please ignore it.

CARE AND MAINTENANCE

Universal booster cushion
Only use authentic T005F seat covers. The seat cover is an integral part of the universal booster cushion and is key to ensure the trouble-free functionality of the system.

Replacement seat covers are available from your dealer.

The cover can be removed and washed with a mild detergent on a washing.

07

08

The plastic parts can be cleaned with soapy water. Do not use any caustic cleaning agents (such as solvents).

TIP! Use seat cover R-elf to assemble cover more easily.



DISPOSAL

Please observe the waste disposal regulations in your country.

Disposal of packaging	Container for cardboard boxes
Seat cover	Residual waste, waste incineration
Plastic parts	To be placed in the corresponding container according to labelling
Metal parts	Container for metals

09

SAFETY NOTES

NOTICE

This is a Universal booster cushion Enhanced Child Restraint System. It is approved according to UN Regulation No.129, for use in i-Size compatible and universal vehicle seating positions as indicated by vehicle manufacturers in the vehicle user's manual.

If in doubt, consult the Enhanced Child Restraint System manufacturer or the retailer.

⚠ DANGER!

Please carefully read and make sure you understand all instructions in this manual and in the vehicle handbook relate to child safety seats. Install and use the child safety seat as described in the instruction manual. Failure to do this could result in serious injury even death of your child. Keep the instructions together with the ECRS for future reference.

MAKE SURE any straps holding the ECRS to the vehicle should be tight. Any straps restraining the

child should be adjusted to the child's body. Make sure straps should not be twisted.

MAKE SURE the lap vehicle seat belt must be worn in such a way as to properly secure the pelvis of the child.

MAKE SURE the ECRS is changed when it has been subject to violent stresses in an accident.

MAKE SURE the rigid items and plastic parts of a ECRS shall be so located and installed that they are not liable, during everyday use of the vehicle, to become trapped by a movable seat or in a door of the vehicle.

DO NOT make any alteration or additions to the ECRS without the approval of the Type Approval Authority, or a danger occurs if not following closely the installation instructions provided by the child restraint manufacturer.

HOT! The child seat should be kept away from sunlight if the seat is not provided with a textile

cover, otherwise it may be too hot for the child's skin.

DO NOT leave your child unattended in this restraint even for a short time.

MAKE SURE any luggage or other objects liable to cause injuries in the event of a collision shall be properly secured.

⚠ DO NOT use the ECRS without the cover. **⚠ DO NOT** replace seat cover with any other than the one recommended by the manufacturer, because the cover constitutes an integral part of the restraint performance.

10



Yangzhou Lettas Baby Product Co., Ltd.

Type: T005F

ID No.: 129-T005F-01

Date: 2023-11-14

Page 29 of 29

Appendix 5: Packing info

<p><i>more than safe</i> REEBABY</p>  <p>T005F UNIVERSAL BOOSTER CUSHION 125-150CM</p> <p>TEL: +86 0514-80326558 YANGZHOU LETTAS BABY PRODUCT CO.,LTD</p> <p>ADD: JIANHUA VILLAGE, HANJIANG DISTRICT, YANGZHOU CITY, JIANGSU PROVINCE, 225127, P.R. CHINA</p> 	<p><i>more than safe</i> REEBABY T005F / 125-150CM</p> <p>SIZE: 125-150CM QTY: 1 PC N.W: XXXX G.W: XXXX CTN SIZE: 46*36*23CM</p> <p>Reebaby www.reebabycn.com</p>
<p><i>more than safe</i> REEBABY</p>  <p>T005 / 125-150CM WAIST CUSHION (OPTIONAL)</p>	<p><i>more than safe</i> REEBABY T005F / 125-150CM</p> <p></p> <p>NOTICE: This is a Universal booster cushion Enhanced Child Restraint System. It is approved according to UN Regulation No.129, for use in i-Size compatible and universal vehicle seating position as indicated by vehicle manufacturers in the vehicle user's manual. If in doubt, consult the Enhanced Child Restraint System manufacturer or the retailer.</p> <p>Reebaby www.reebabycn.com</p>

