

PORTABICI  
BIKE CARRIERS  
PORTABICICLETAS  
PORTE-VÉLOS  
FAHRRADTRÄGER

**MENABO**  
free time on the move

## LYRA





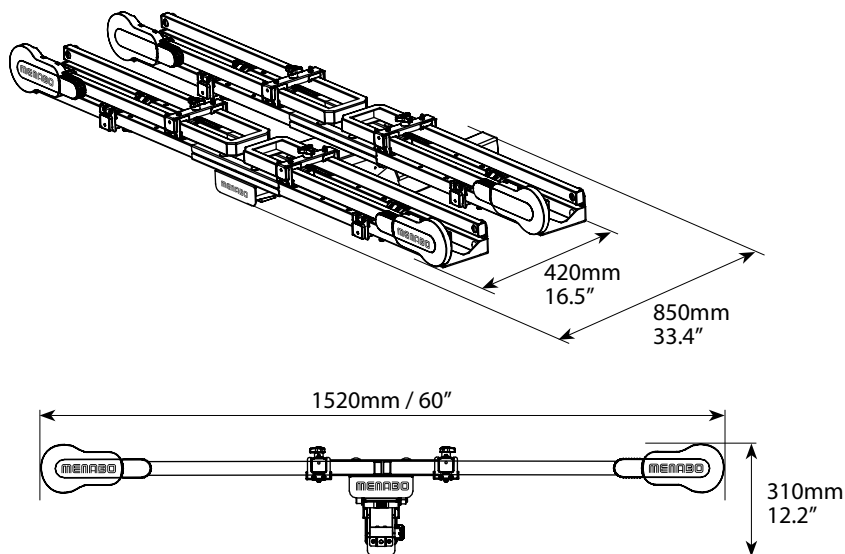

Portabici da hitch con struttura in acciaio di alta qualità. Progettato per trasportare fino a 2 biciclette, incluse e-bike, grazie alla sua elevata capacità di carico. Dotato di un pratico sistema di ribaltamento che consente l'accesso al baule dell'auto anche con le biciclette montate. Include sistema antifurto integrato che protegge il portabici stesso.

Sturdy hitch bike rack with high-quality steel frame. Designed to carry up to 2 bicycles, including e-bikes, thanks to its high load capacity. Equipped with a practical tilting system that allows access to your car's trunk even with bikes mounted. Includes integrated anti-theft system that protects the bike rack itself.









Lyra	Art.000160500000
 <b>Peso prodotto</b> Product weight	23,9 kg / 52.7 lb
<b>Materiale</b> Material	Acciaio Steel
 <b>Portata massima</b> Max load	max 50kg / 110lb
 <b>Antifurto portabici</b> Anti-theft for the bike rack	✓
 <b>Antifurto bici</b> Anti-theft for the bike	✓
	x2
E-bike	✓
Fat bike	x

**Product logistics**



**COMPATIBILITÀ BICI / BIKE COMPATIBILITY**

Mod.				
LYRA	-	min 22" max 29"	max 75mm/3"	max 2000mm/78.7"

**F.lli Menabò s.r.l.**

Via 8 Marzo 3,  
42025 Cavriago (RE), Italy  
+39-0522/942840  
customer@flli-menabo.it  
www.menabocaraccessories.com